

1

2

3

4

5

6

7

8

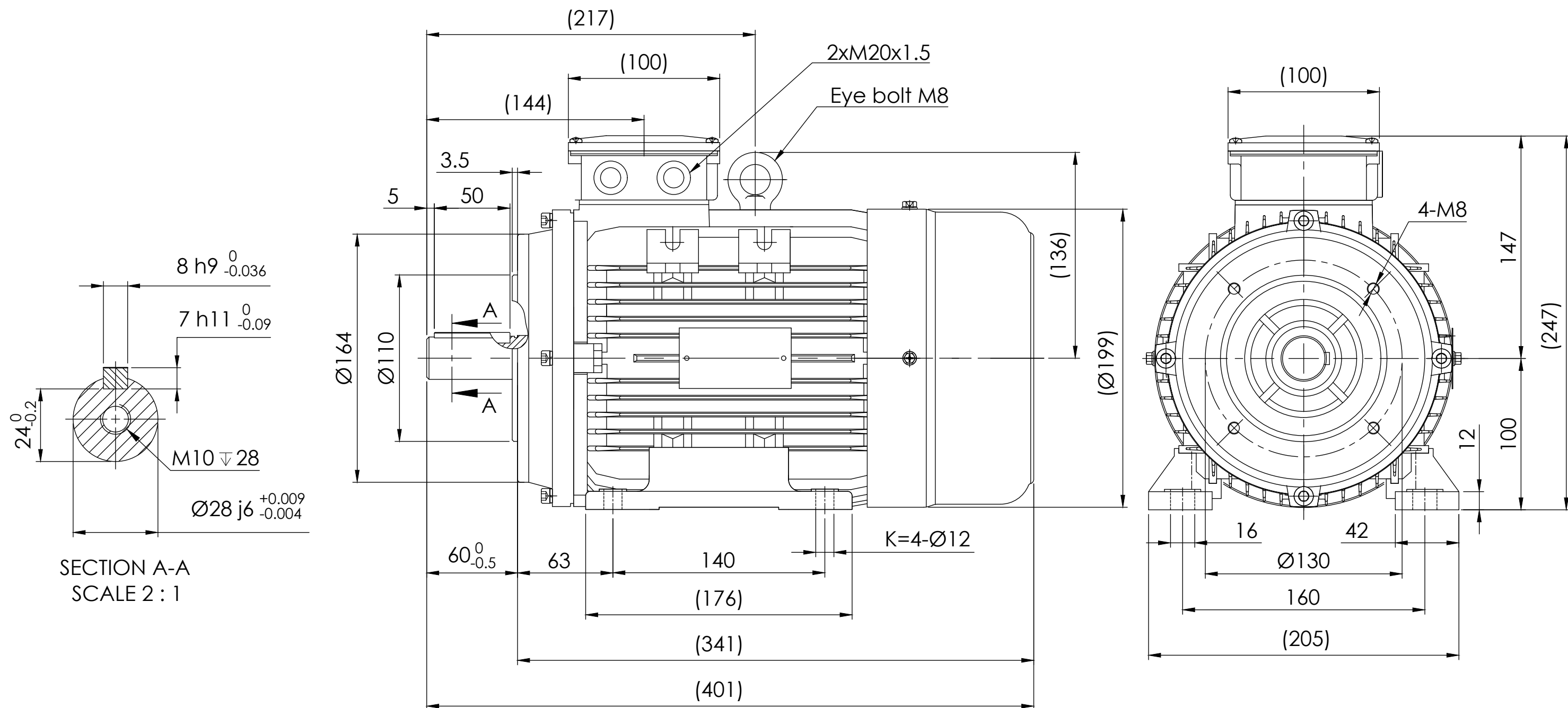

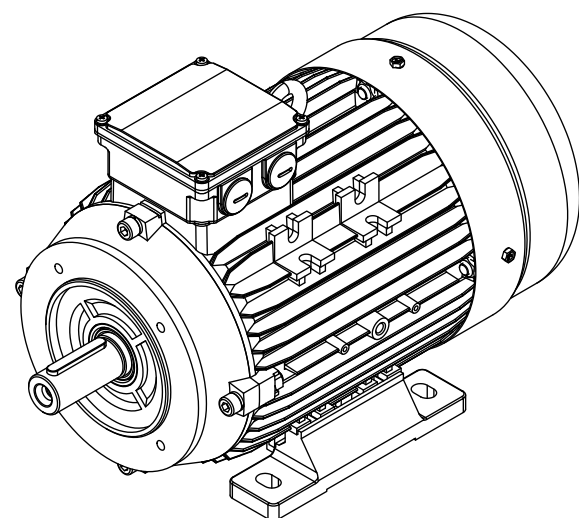

SECTION A-A
SCALE 2 : 1



Note:

1. All dimensions are in mm
2. Tolerances not informed on the drawing according to the mounting tolerance table.

Mounting tolerance		 <small>EXCEEDING EXPECTATIONS</small>		Hoyer Motors			DEBUR AND BREAK SHARP EDGES		DRAWING NOT IN SCALE	
Dimensions range	Tolerance			REV.	LOCATION	DESCRIPTION	DATE	RESP.	APPROVED	OUTLINE DRAWING
0<D≤400	±10	0	N/A	First issued	06/06/2024	L&T	Hoyer	TITLE: HMA4-100L-6p-B34		
400<D≤1000	±20							DWG NO.: TD-ID-D2152		
1000<D≤2000	±30							A3		
2000<D≤4000	±35							SCALE:1:1		
4000<D≤8000	±40							Weight: 30 kg		
Unit: mm								SHEET 1 OF 1		
 Representation of the machine is illustrative only Some features may not be represented For installation or maintenance, consult operation manual				Protection:	IEC 60034-5	Machined Part:	ISO 2768	DWG NO.: TD-ID-D2152 A3		
				Dimension:	IEC 60072	Weld Constr:	ISO 8015			
				Tolerance:	ISO 286	Castings:	ISO 8062			
				Key:	IEC 60072					