

1

2

3

4

5

6

7

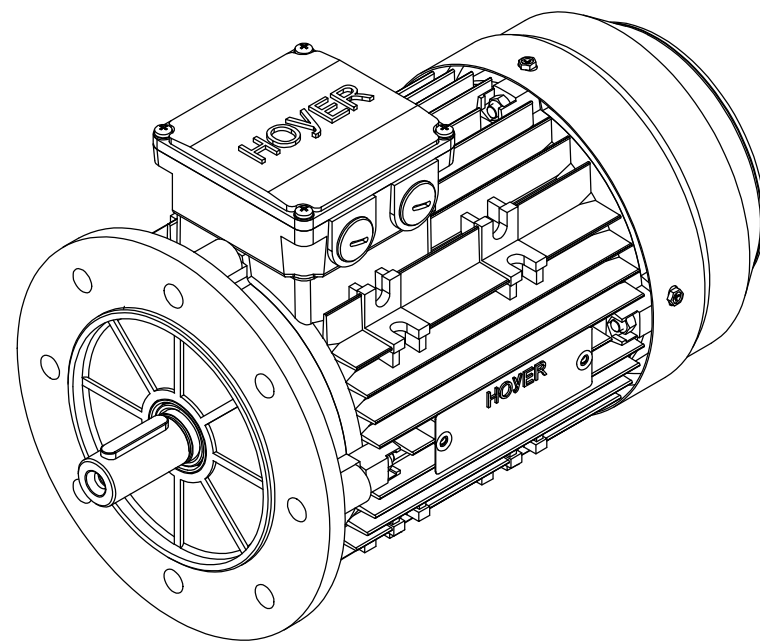
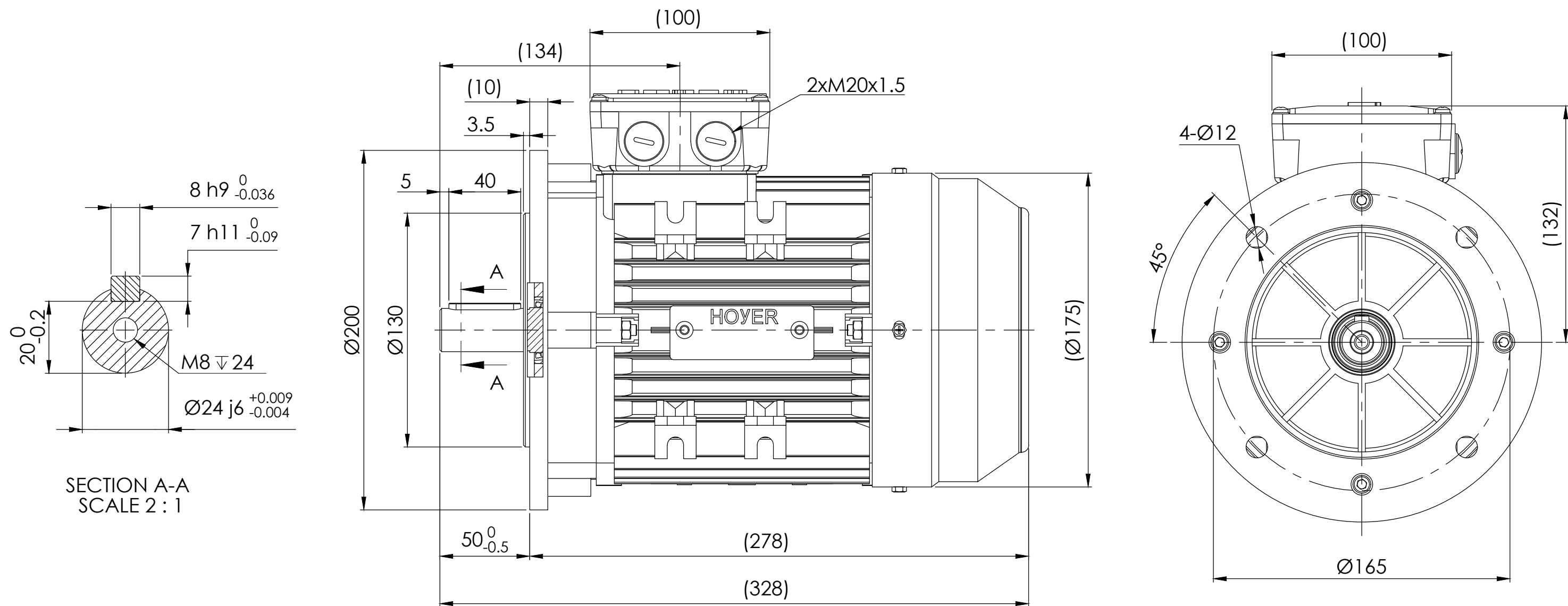

8



Note:

1.All dimensions are in mm

2.Tolerances not informed on the drawing according to the mounting tolerance table.

Mounting tolerance		Hoyer Motors		DEBUR AND BREAK SHARP EDGES		DRAWING NOT IN SCALE	
Dimensions range	Tolerance	 Over Hadstenvej 42, DK-8370 Hadsten Tel : +45 86982111 Fax: +45 86981779 www.hoyermotors.com				OUTLINE DRAWING	
0<D≤400	±10	REV.	LOCATION	DESCRIPTION	DATE	RESP.	APPROVED
400<D≤1000	±20	0	N/A	First issued	21/10/2024	L&T	Hoyer
1000<D≤2000	±30						
2000<D≤4000	±35						
4000<D≤8000	±40						
Unit: mm							
 Representation of the machine is illustrative only Some features may not be represented For installation or maintenance, consult operation manual		Protection:	IEC 60034-5	Machined Part:	ISO 2768	TITLE:	
		Dimension:	IEC 60072	Weld Constr:	ISO 8015	HMA3-90S-6p-B5	
		Tolerance:	ISO 286	Castings:	ISO 8062	DWG NO.:	
		Key:	IEC 60072			TD-ID-D3639	
						SCALE:1:5	Weight: 15.2 kg
						SHEET 1 OF 1	