

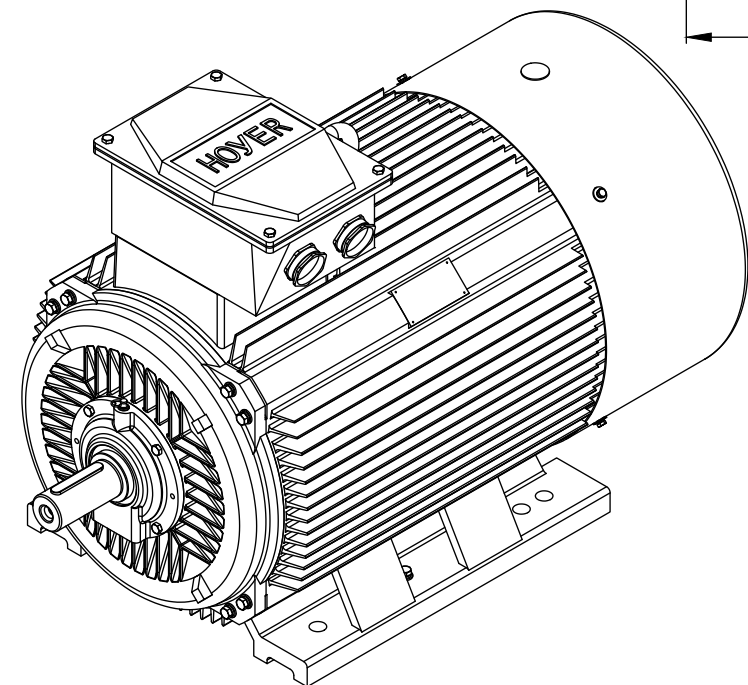

SECTION A-A
SCALE 1 : 3

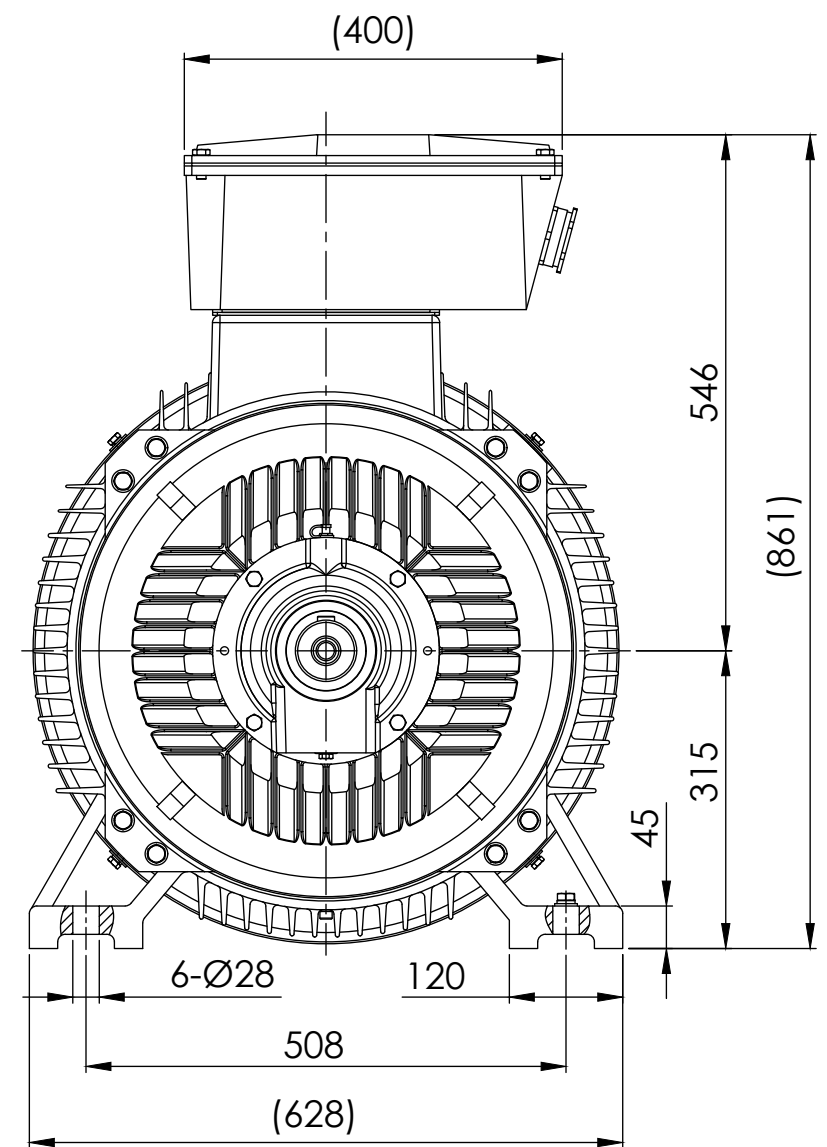
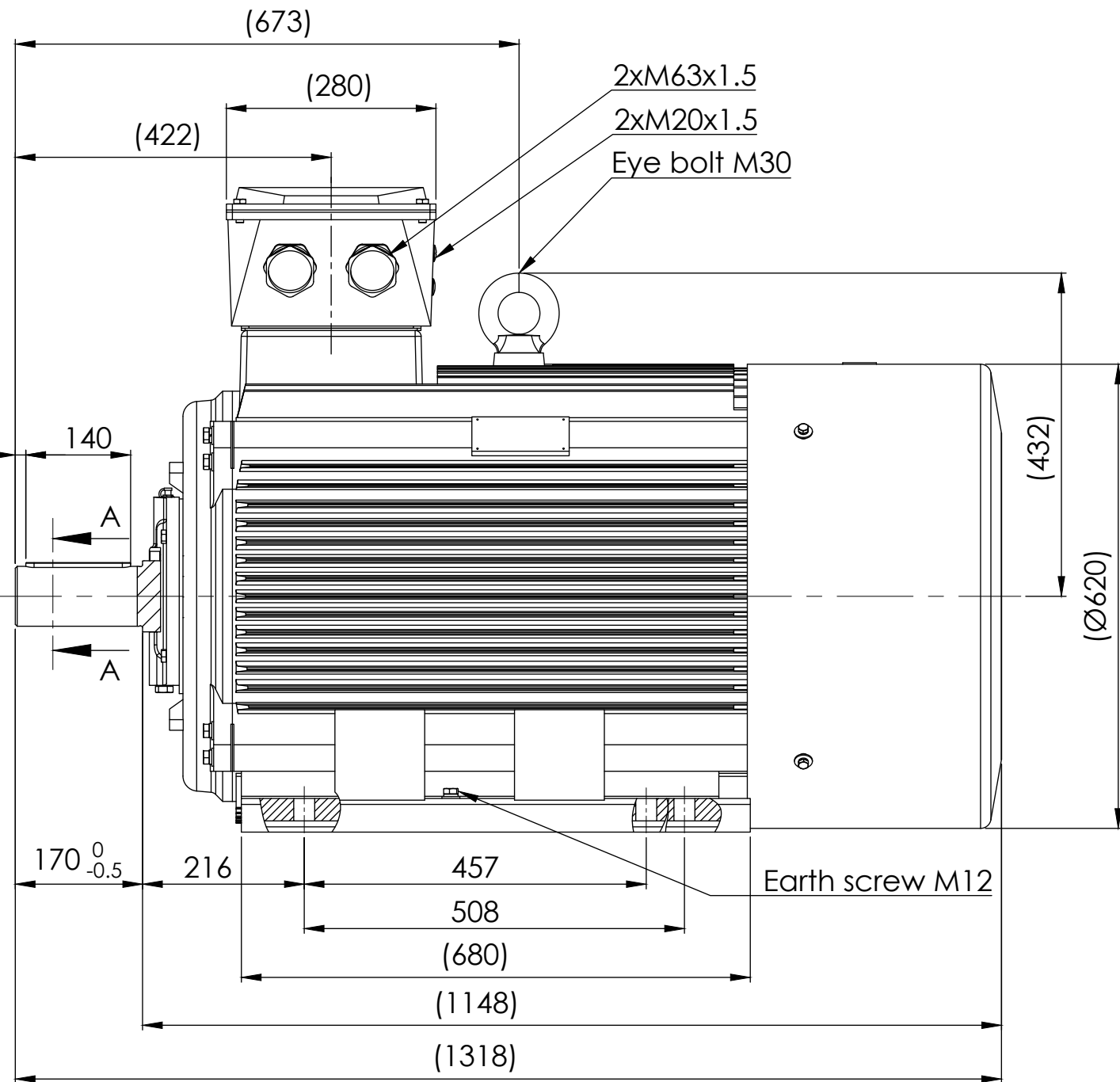

Note:

- 1.All dimensions are in mm
- 2.Tolerances not informed on the drawing according to the mounting tolerance table.

Mounting tolerance				Hoyer Motors			DEBUR AND BREAK SHARP EDGES		DRAWING NOT IN SCALE	
Dimensions range	Tolerance			Over Hadstenvej 42, DK-8370 Hadsten Tel : +45 86982111 Fax: +45 86981779 www.hoyermotors.com					OUTLINE DRAWING	
0<D≤400	±10	REV.	LOCATION	DESCRIPTION	DATE	RESP.	APPROVED	TITLE: HMC2-315L1-4p-B3		
400<D≤1000	±20	0	N/A	First issued	27/06/2024	L&T	Hoyer			
1000<D≤2000	±30									
2000<D≤4000	±35									
4000<D≤8000	±40									
Unit: mm										
		Representation of the machine is illustrative only			Protection:	IEC 60034-5	Machined Part:	ISO 2768	DWG NO.: TD-ID-D2284	A3
		Some features may not be represented			Dimension:	IEC 60072	Weld Constr:	ISO 8015		
		For installation or maintenance, consult operation manual			Tolerance:	ISO 286	Castings:	ISO 8062		
				Key:	IEC 60072			SCALE:1:10	Weight: 982 kg	SHEET 1 OF 1