

1

2

3

4

5

6

7

8

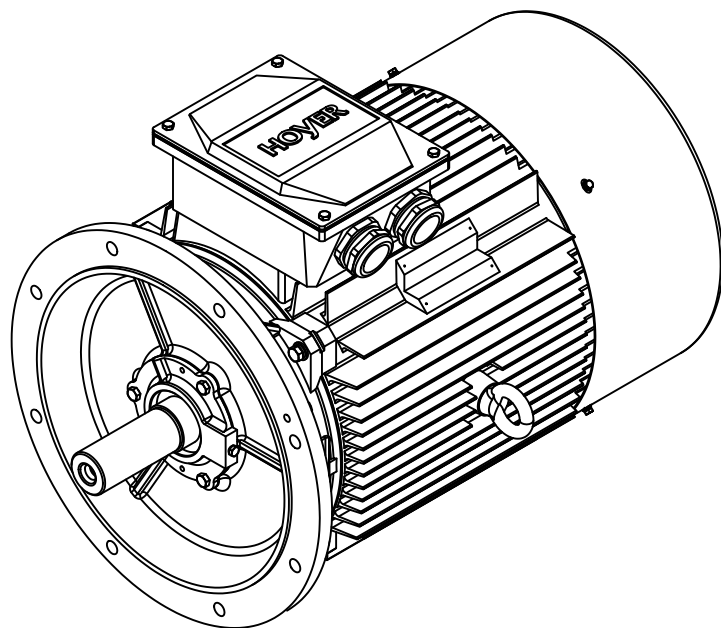
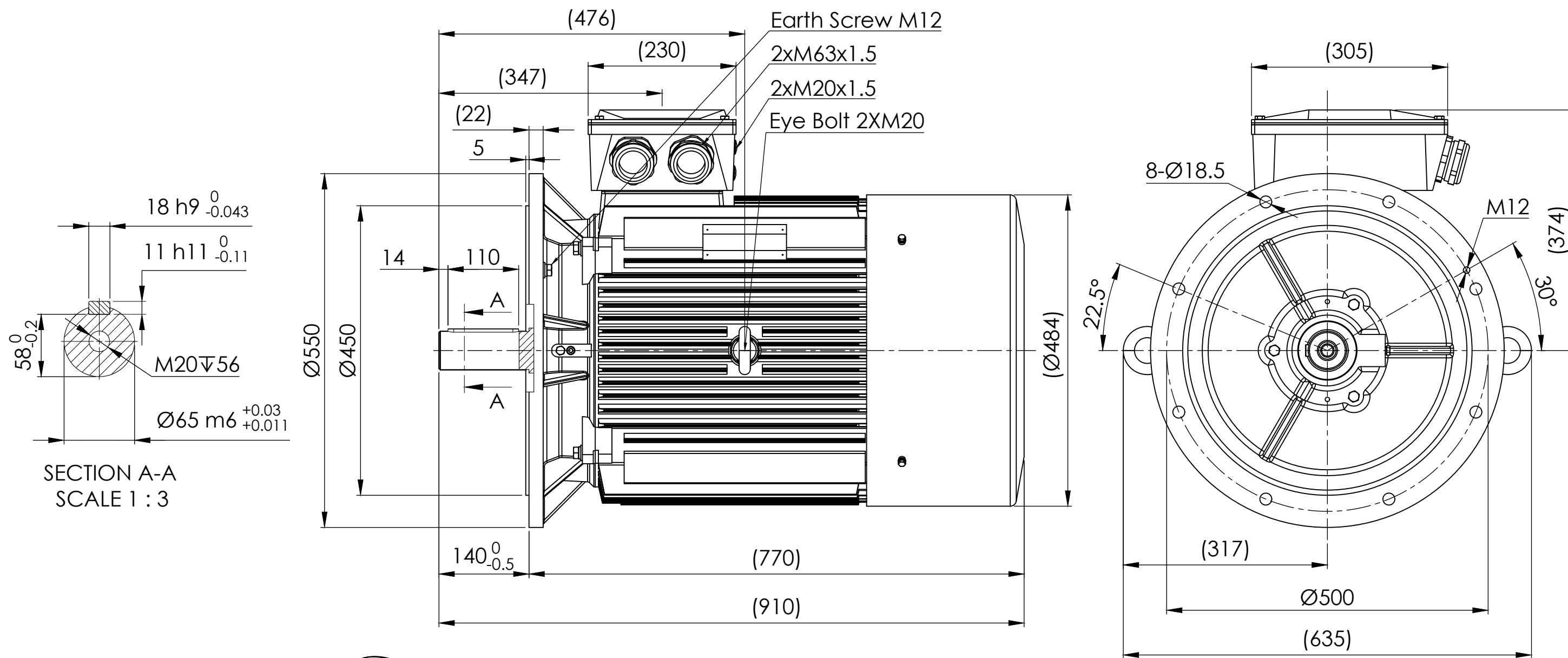

Note:

1. All dimensions are in mm
2. Tolerances not informed on the drawing according to the mounting tolerance table.

Mounting tolerance		HOYER EXCEEDING EXPECTATIONS		Hoyer Motors Over Hadstenevej 42, DK-8370 Hadsten Tel : +45 86982111 Fax: +45 86981779 www.hoyermotors.com			DEBUR AND BREAK SHARP EDGES	DRAWING NOT IN SCALE	
Dimensions range	Tolerance	REV.	LOCATION	DESCRIPTION	DATE	RESP.	APPROVED	OUTLINE DRAWING	
0<D≤400	±10	0	N/A	First issued	24/06/2024	L&T	Hoyer	TITLE: HMC2-250M-4p-B5	
400<D≤1000	±20							DWG NO.: TD-ID-D70098	
1000<D≤2000	±30							A3	
2000<D≤4000	±35							SCALE:1:10	
4000<D≤8000	±40							Weight: 415 kg	
Unit: mm								SHEET 1 OF 1	
Representation of the machine is illustrative only Some features may not be represented For installation or maintenance, consult operation manual				Protection:	IEC 60034-5	Machined Part:	ISO 2768	DWG NO.:	
				Dimension:	IEC 60072	Weld Constr:	ISO 8015		
				Tolerance:	ISO 286	Castings:	ISO 8062		
				Key:	IEC 60072				