

1

2

3

4

5

6

7

8

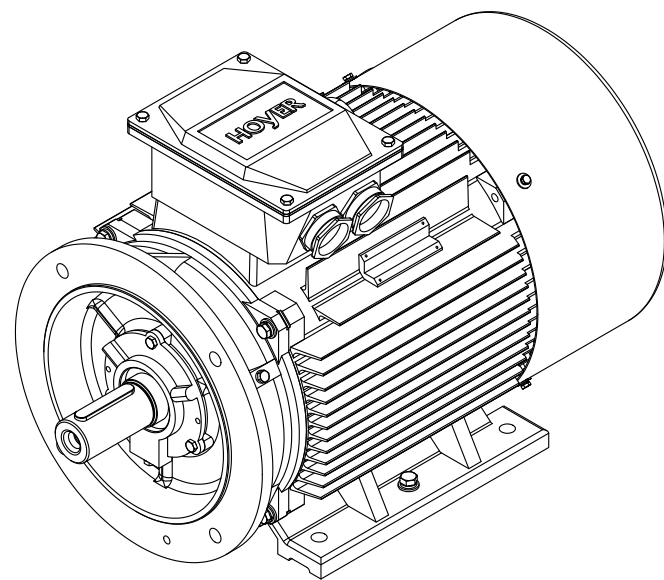
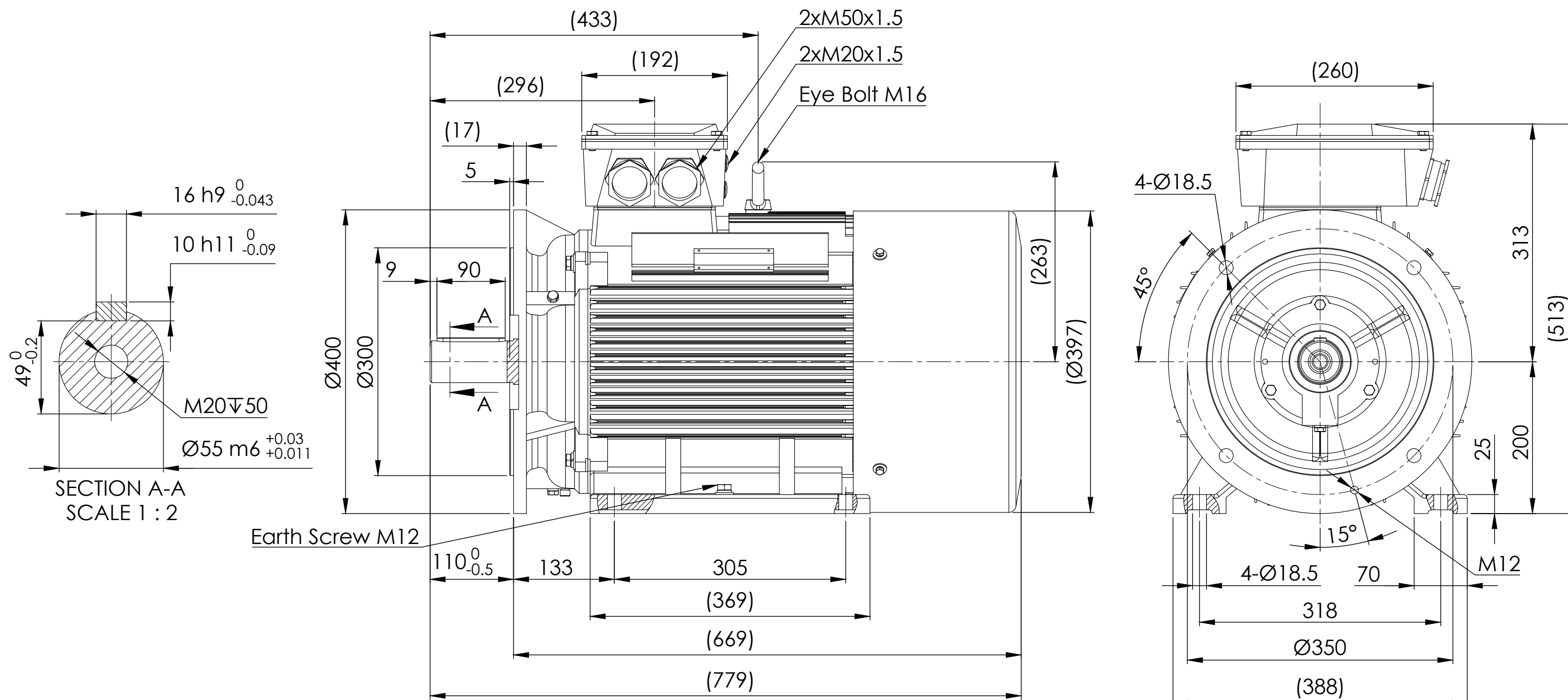

Note:

1.All dimensions are in mm

2.Tolerances not informed on the drawing according to the mounting tolerance table.

Mounting tolerance		Hoyer Motors		DEBUR AND BREAK SHARP EDGES		DRAWING NOT IN SCALE	
Dimensions range	Tolerance	Hoyer Motors		Over Hadstenevej 42, DK-8370 Hadsten		OUTLINE DRAWING	
0<D≤400	±10	Tel : +45 86982111		Fax: +45 86981779		TITLE:	
400<D≤1000	±20	www.hoyermotors.com		www.hoyermotors.com		HMC2-200L-4p-B35	
1000<D≤2000	±30	REV.	LOCATION	DESCRIPTION	DATE	RESP.	APPROVED
2000<D≤4000	±35	0	N/A	First issued	18/06/2024	L&T	Hoyer
4000<D≤8000	±40						
Unit: mm							
Representation of the machine is illustrative only		Protection: IEC 60034-5		Machined Part: ISO 2768		DWG NO.:	
Some features may not be represented		Dimension: IEC 60072		Weld Constr: ISO 8015		TD-ID-D2244	
For installation or maintenance, consult operation manual		Tolerance: ISO 286		Castings: ISO 8062		A3	
Key: IEC 60072						SCALE:1:10	
						Weight: 245 kg	
						SHEET 1 OF 1	