

A

B

C

D

E

F

A

B

C



D

E

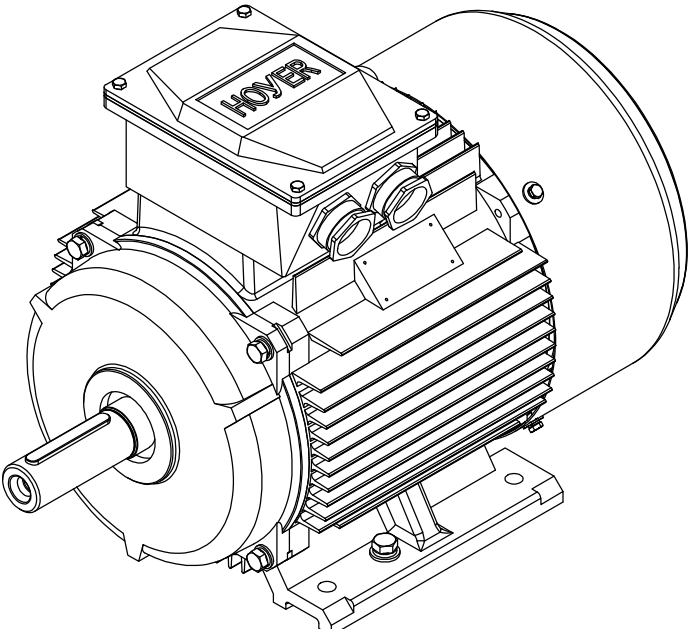
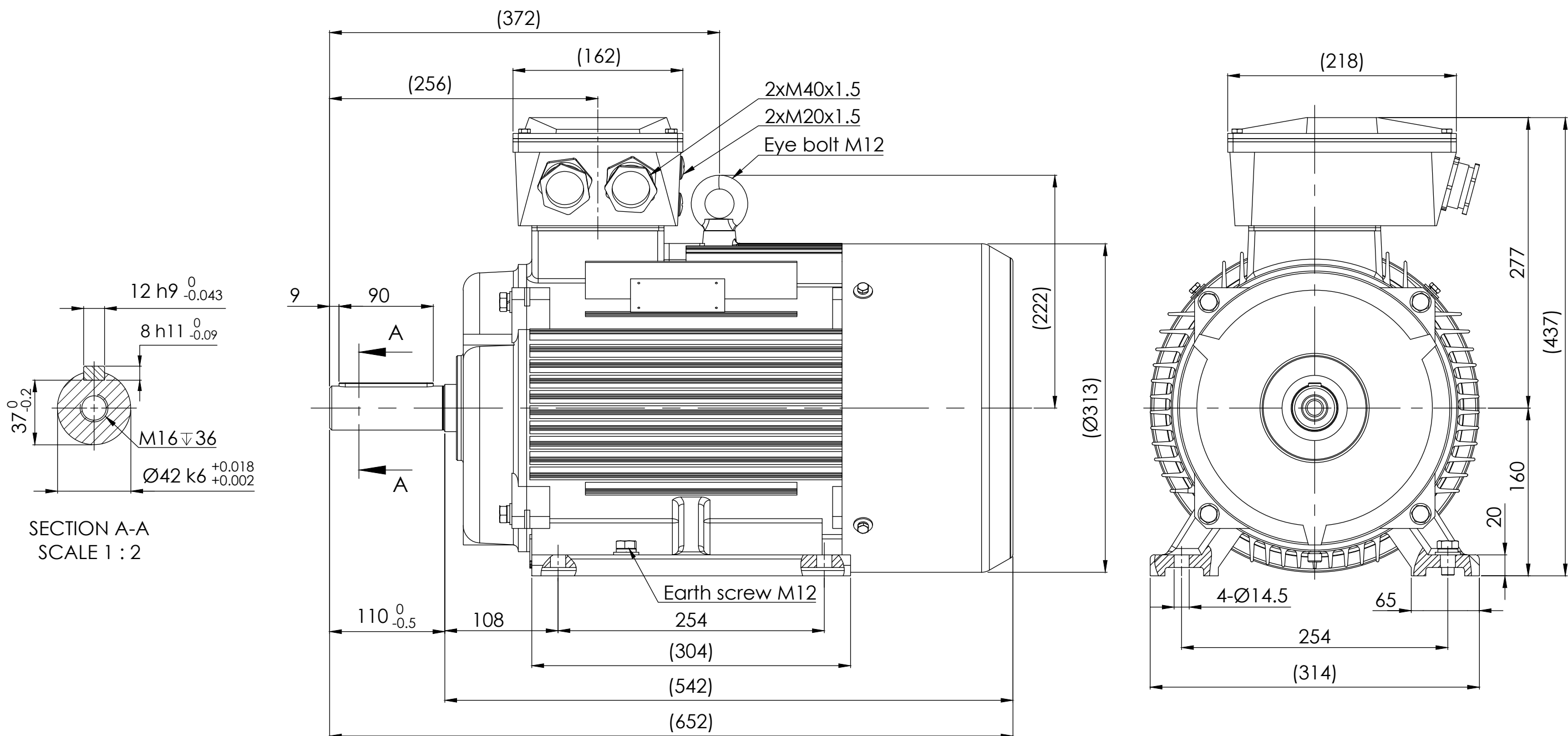
F



Note:
 1.All dimensions are in mm
 2.Tolerances not informed on the drawing according to the mounting tolerance table.

Mounting tolerance				Hoyer Motors			DEBUR AND BREAK SHARP EDGES		DRAWING NOT IN SCALE		
Dimensions range	Tolerance			Over Hadstenevej 42, DK-8370 Hadsten Tel : +45 86982111 Fax: +45 86981779 www.hoyermotors.com					OUTLINE DRAWING		
0<D≤400	±10	REV.	LOCATION	DESCRIPTION	DATE	RESP.	APPROVED	TITLE: HMC2-160L-6p-B3			
400<D≤1000	±20	0	N/A	First issued	21/06/2024	L&T	Hoyer				
1000<D≤2000	±30										
2000<D≤4000	±35										
4000<D≤8000	±40										
Unit: mm											
 Representation of the machine is illustrative only Some features may not be represented For installation or maintenance, consult operation manual		Protection:		IEC 60034-5	Machined Part:		ISO 2768	DWG NO.: TD-ID-D2206			
		Dimension:		IEC 60072	Weld Constr:		ISO 8015				
		Tolerance:		ISO 286	Castings:		ISO 8062				
		Key:		IEC 60072					SCALE:1:5		
								Weight: 150 kg		SHEET 1 OF 1	