

1

2

3

4

5

6

7

8

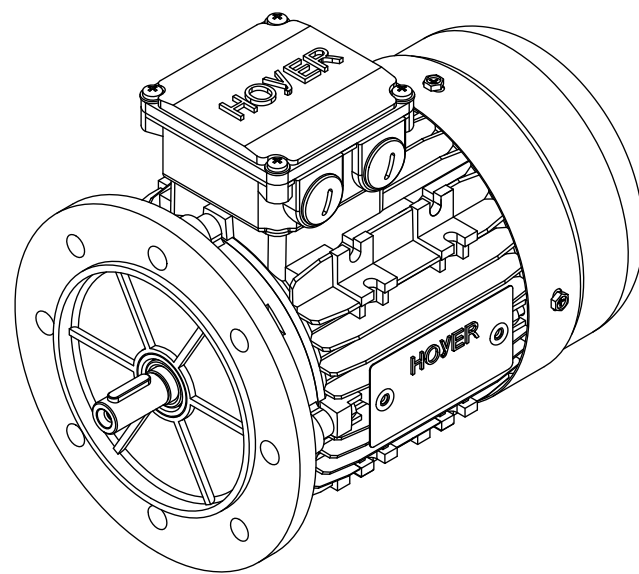
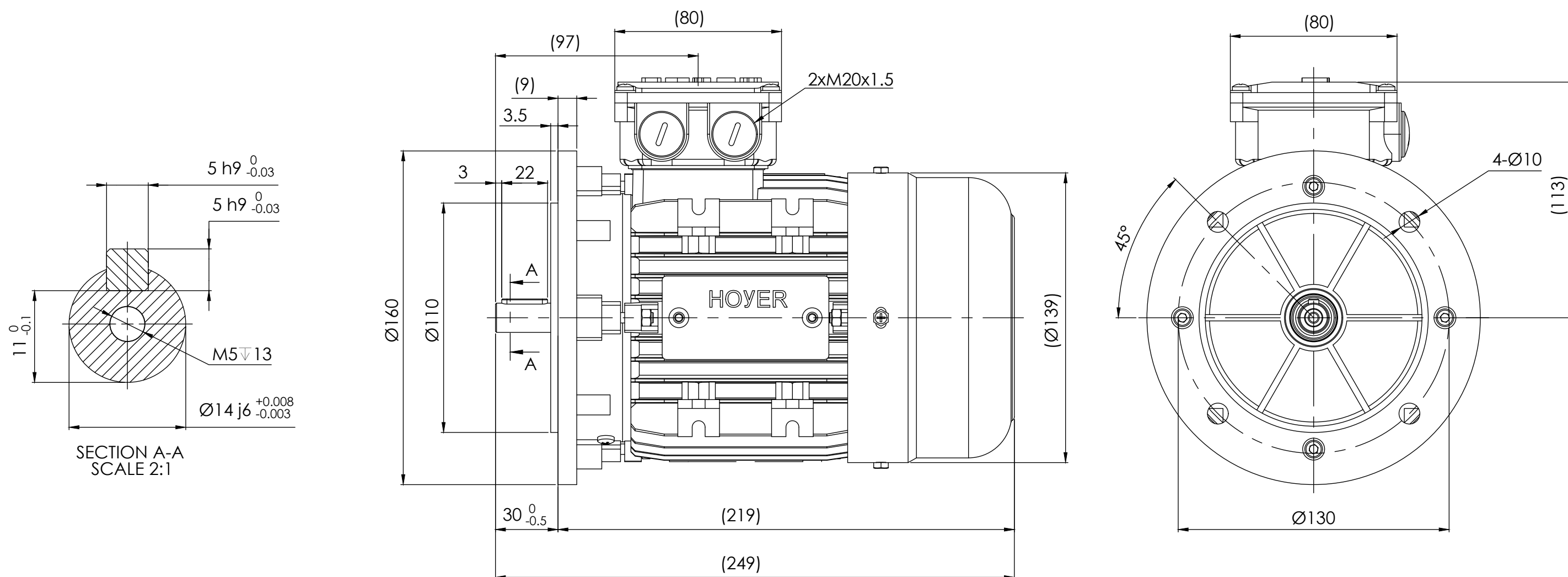

Note:

- All dimensions are in mm
- Tolerances not informed on the drawing according to the mounting tolerance table.

Mounting tolerance		Hoyer Motors		DEBUR AND BREAK SHARP EDGES		DRAWING NOT IN SCALE	
Dimensions range	Tolerance	 Over Hadstensevej 42, DK-8370 Hadsten Tel : +45 86982111 Fax: +45 86981779 www.hoyermotors.com				OUTLINE DRAWING	
0<D≤400	±10	REV.	LOCATION	DESCRIPTION	DATE	RESP.	APPROVED
400<D≤1000	±20	0	N/A	First issued	30/07/2024	L&T	Hoyer
1000<D≤2000	±30						
2000<D≤4000	±35						
4000<D≤8000	±40						
Unit: mm							
Representation of the machine is illustrative only		Protection: IEC 60034-5		Machined Part: ISO 2768		DWG NO.: TD-ID-D2557	
Some features may not be represented		Dimension: IEC 60072		Weld Constr: ISO 8015		A3	
For installation or maintenance, consult operation manual		Tolerance: ISO 286		Castings: ISO 8062		SCALE:1:5	
		Key: IEC 60072				Weight: 6 kg	
						SHEET 1 OF 1	